

**BRAVO COMMUNICATIONS, INC.**  
**SURE/FIRE® 4-PORT LAN/NETWORK HUB PROTECTOR**

**MODEL BNC/LANHUB**

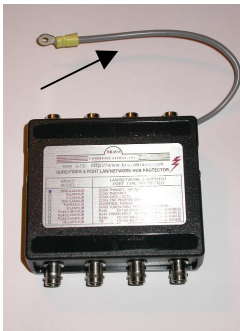

- ◆ Protects Ethernet/ThinNet, ARCNET, 3270, Audio, Video And Other BNC Coaxial Cable Equipment And Networks
- ◆ Protects Both Center Pin And Shield Wires Per Port Up To 30 Mhz With Straight-Thru Wiring
- ◆ 4-Port Building Block Architecture With Single-Point Grounding
- ◆ BNC Hubs Normally Come As Female/Female Connections. Male/Female & Male/Male Is Also Available
- ◆ Each Hub Module Includes Four Convenient Grounding Screw Locations--Two On The Bottom Side And Two On The Sides
- ◆ 4-Port Modules Can Be Stacked Vertically And Horizontally For Unlimited Hub Expansion And Modularity As The Network Grows Or Changes
- ◆ Allows The Network Designer To Wall Mount, Desk Mount, Or Equipment Mount Directly To Premise Earth Grounding System Or Chassis/Frame Ground Or As Desired
- ◆ Comes Complete W/ 2 Grounding Brackets, A 12 AWG Ground Wire & 4 Rubber Feet
- ◆ Individual LAN Port Surge Test Light For All Ports (Diamond-Shaped Red LED)
- ◆ Hubs Come In Injection Molded, Fire Retardent Plastic. Hub Front And Back Panels Can Be Color Coded For Easy Port Identification (Black Is Standard). Heavy-Duty Shielded Painted Aluminum Hubs Are Also Available.
- ◆ Individual Hub Modules Are Hot Swappable In The System
- ◆ Stops All Voltage Transients Greater Than  $\pm 8$  Volts & Up To 25K Amps Per Line In < A Pico-Second.
- ◆ Protects LAN Equipment Repeatedly And Then Automatically Resets Itself
- ◆ Unique 3-Stage Protection On All Signal Lines Is Powerful Enough To Use For Both Inter-Building And Intra-Building Cable Run Installations.
- ◆ Generally suitable for both 50 ohm and 75 ohm impedance circuits.
- ◆ 5-Year Limited Warranty



**TOP VIEW WITH GROUND WIRE**

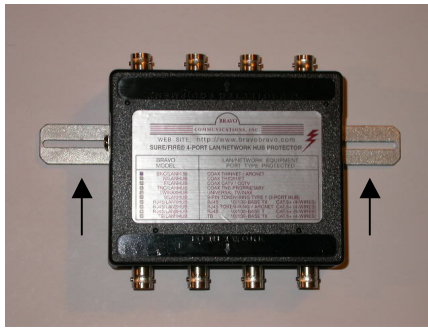

**WALL-MOUNT VIEW WITH GROUND BRACKETS FOR VERTICAL BNC CABLE RUNS**

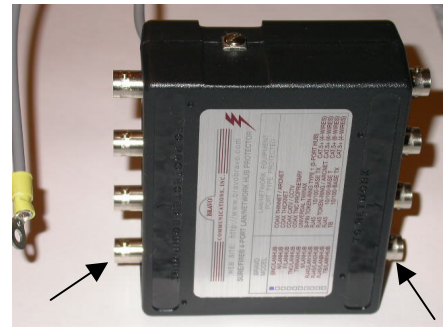

**90° TOP VIEW FOR HORIZONTAL BNC CABLE RUNS**

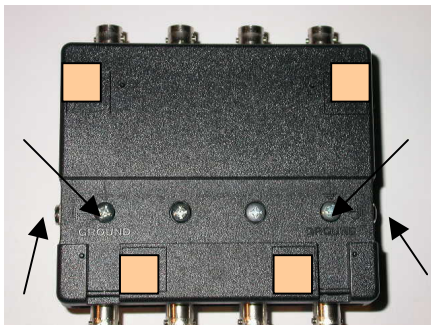

**BOTTOM VIEW WITH 4 GROUNDING LOCATIONS & 4 RUBBER FEET AREAS**

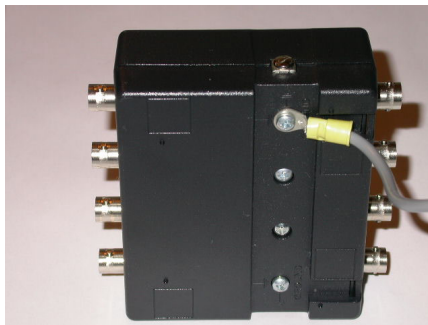

**90 ° BOTTOM VIEW WITH HUB GROUND WIRE**

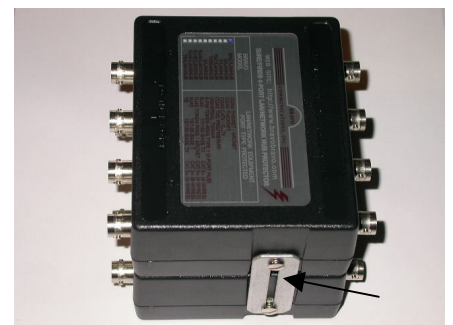

**SIDE VIEW WITH 2 HUB VERTICAL STACKING**

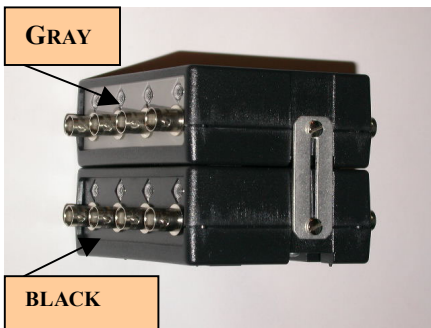

**MULTI-VIEW WITH VERTICAL STACKING USING COLOR CODED PANELS**

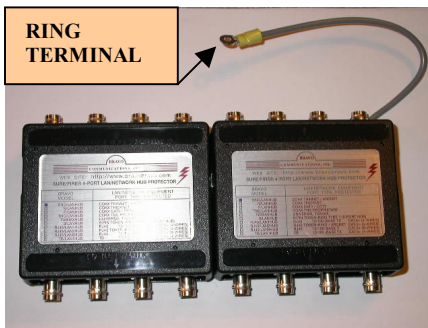

**TOP VIEW WITH HORIZONTAL STACKING & 12 AWG GROUND WIRE**

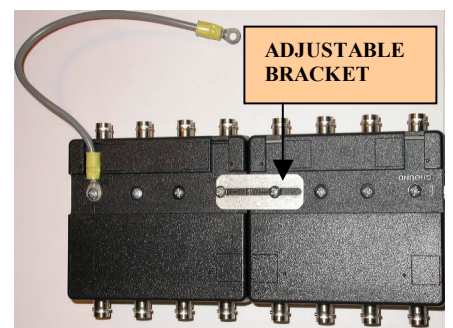

**BOTTOM VIEW WITH HORIZONTAL STACKING**

# **SURGE PROTECTION BUILDING BLOCKS**

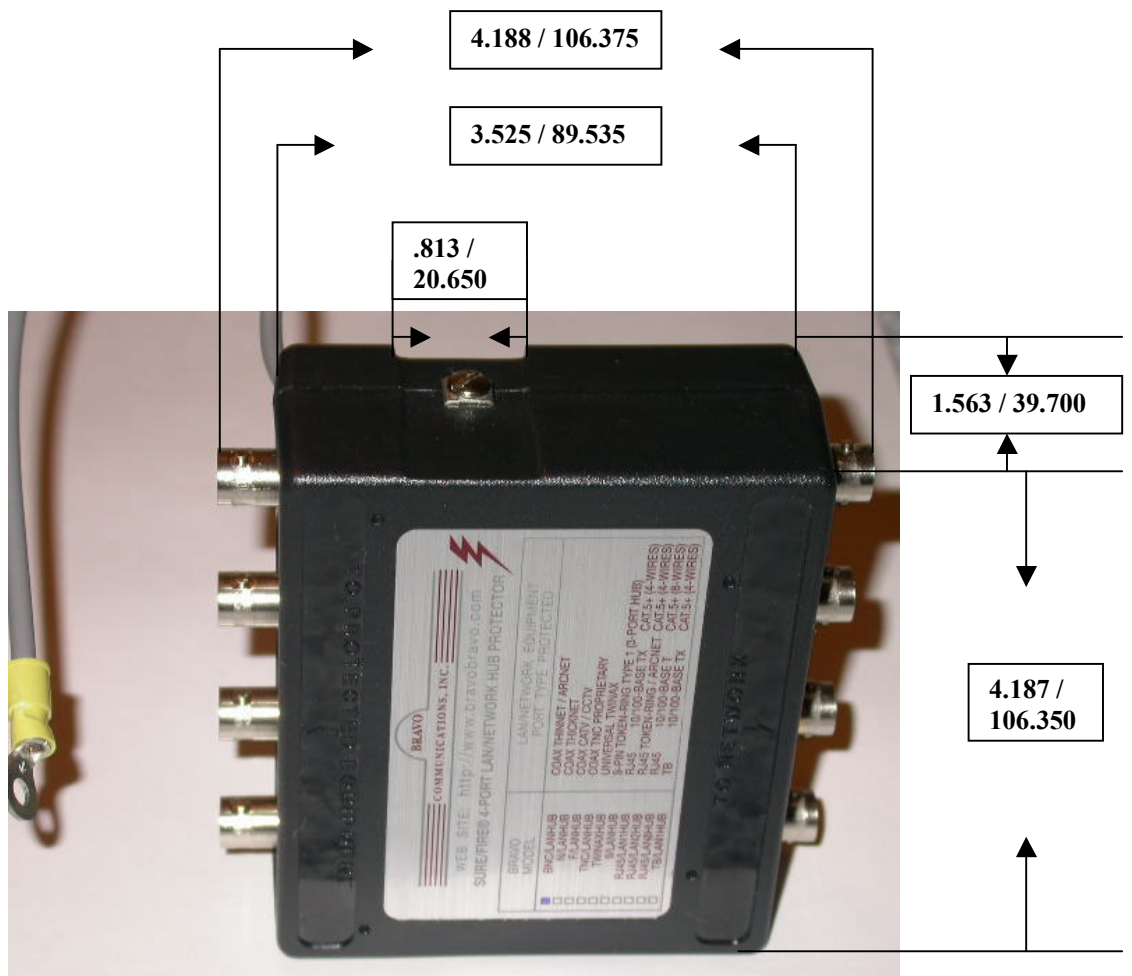

Note: All dimensions are specified as inches / millimeters.

BRAVO COMMUNICATIONS, INC.  
 3463 MEADOWLANDS LN  
 SAN JOSE, CA 95135 U.S.A.

PART NUMBER: BNC/LANHUB